

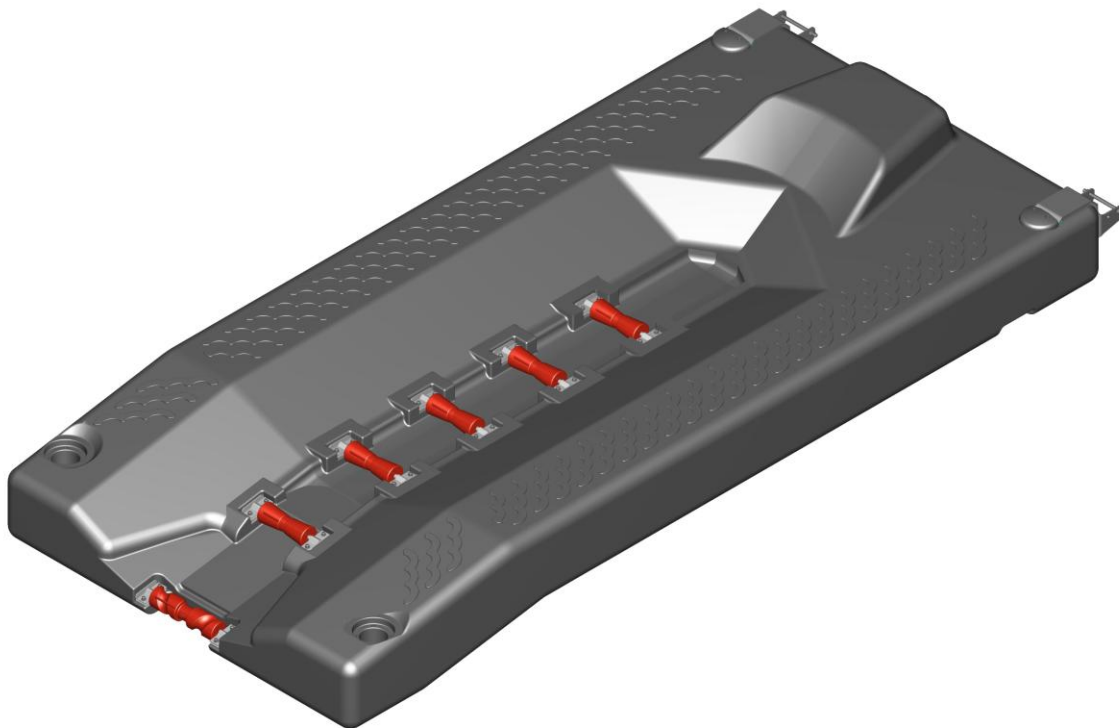

PERMAPORT

ASSEMBLY, INSTALLATION AND MAINTENANCE INSTRUCTIONS

(Permaport and Permaport plus)



It is important that these instructions are adhered to in their entirety. Please read the instructions fully before starting installation or assembly.



Contents

• Safety Instructions (installation)	3
• Safety Instructions (Use)	3
• Instructions for Use	3
• Installation Considerations	4
• Parts list for Permaport	5
• Parts list for Front Mount Floating Dock Attachments	6
• Parts list for Front Mount Fixed Dock Attachments	7
• Parts List for Side Mount attachments	8
• Basic Assembly Instructions (Front Mount)	9
• Basis Assembly Instructions (Side Mount)	10
• Assembly Instructions (Floating Dock Front Mount)	11
• Assembly Instructions (Fixed Dock Front Mount)	12
• Assembly Instructions (Side mount)	13
• Exploded view of Front Mount Assembly (Fixed Dock)	14
• Exploded view of Front Mount Assembly (Floating Dock)	15
• Exploded view of Side Mount Assembly	16



Safety Instructions (Installation)

- Many of the parts of the permaport are heavy; do not lift any parts that are beyond your capability, use additional help to maneuver parts into position.
- When working near the water it may be advisable to tie a line to any parts that are liable to sink until they are attached. These should be attached to inanimate secure objects only.
- Installation to the dock requires holes to be drilled and possibly wood to be cut, these operations should only be carried out by competent persons.
- Water and electricity do not mix well, do not use corded power tools, hand tools are preferable or battery powered. Battery powered tools up to 20v are safe but will be damaged if submerged.
- If you have any doubt about installing the Permaport consult the Dock Specialist that supplied the unit.

Safety Instructions (Use)

- The Permaport has Heavy Duty Steel attachments for long life and durability. These components are heavy and extend below the water line below the Permaport. It is inadvisable to swim near, under or from the Permaport due to the possibility of entrapment or injury from protruding parts.
- Entry onto the Permaport is designed to be a low speed operation; it is advisable that the Watercraft be brought to a complete standstill in line with the Permaport with the bow keel touching the self centering entry roller. A small amount of throttle is all that is required in order to propel the watercraft on to the Permaport. Do not vacate the watercraft until it is fully stationary and the engine is turned off.
- Do not load or unload the watercraft with passengers other than the driver.
- Ensure that there are no obstructions or persons in the water near the permaport or on the Permaport when loading or unloading the watercraft.
- Stop engine as soon as the Watercraft is on the Permaport, do not allow engine to run whilst out of the water. Do not start the engine whilst the watercraft is on the Permaport. Refer to Watercraft owner's manual for further details.



Mounting Hardware

Watercraft dock floats should be mounted at the front out of preference, side mounting systems are available but mounting this way transfers the pivot point parallel to the length of the Permaport and prevents correct movement of the rear when loading and loading.

There are two basic mounting systems, one for floating Docks and one for fixed docks; under no circumstances should a floating dock mounting system be used on a fixed dock.

It is advisable that this dock be installed by a professional dock builder. Failure to mount the dock in accordance with the manufacturer's instructions will invalidate the warranty.

Tools required

The Permaport has been designed to be installed with the minimum amount of assembly and requiring only basic tools.

Note: It is essential that any electrical tools used outdoors be protected by adequate GFCI protection, we recommend that only hand or Battery operated tools be used in close proximity to water

- 3/4" Wrench or Long Reach Socket and ratchet drive (Preferred)
- Drill and 9/16" Drill Bit
- Wrench or Socket and Ratchet Drive
- For a fixed dock installation the vertical support poles need to be driven into the lake bed, it is recommended that at least a manual fence post driver be utilized for this purpose.

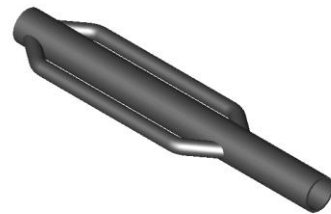

Maintenance

The only maintenance that is required is the periodic greasing of the Roller Axles, remove the top caps from the Roller assembly and slide the roller off of the shaft, spray with a dry lube (available from most Hardware stores) and replace assembly. We recommend that this be carried out once a year or if the rollers appear to be stiff in operation.



Permaport Parts List

Ensure that all of the parts are available before starting assembly.

- 1 Permaport Hull Including 6 Fitted Rollers
(5 straight and one self centering)

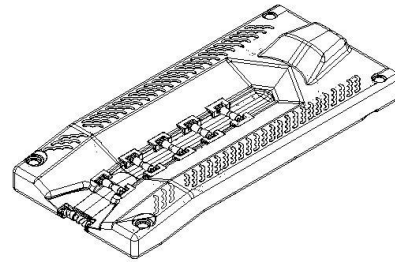

- 1 Cleat

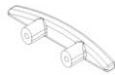

- 2 Screws for Cleat



- 2 Top Caps











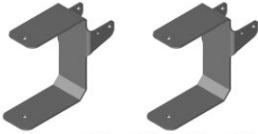

- 4 Wear Plates

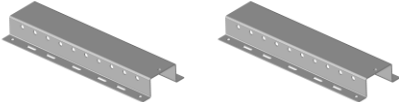



Floating Dock Attachment Kit (Front Mount)











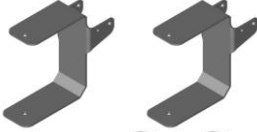

Ensure that all of the parts are available before starting assembly.

- 2 C Brackets 
- 4 Self Tapping Screws 
- 2 1/2" x 13" Stainless Steel Bolts 
- 2 Dock Brackets 
- 2 1/2" x 7" Stainless Steel Bolts 
- 6 1/2" Stainless Steel Washers 
- 4 1/2" Nylock Nuts 
- 8 3/8" x 4" Carriage Bolts 
- 8 3/8" Nuts 
- 8 3/8" lock washers 
- 8 3/8" Flat Washers 
- 4 9/16" Flat Plastic Washers 



Fixed Dock Attachment Kit (front Mount)











Ensure that all of the parts are available before starting assembly.

- 2 C Brackets 
- 4 Self Tapping Screws 
- 2 1/2" x 13" Stainless Steel Bolts 
- 2 Swivel Mounts 
- 2 Pipe Clamps 
- 2 1/2" x 7" or 8" Stainless Steel Bolts 
- 6 1/2" Stainless Steel Washers 
- 4 1/2" Nylock Nuts 
- 8 3/8" x 4" Carriage Bolts 
- 8 3/8" Nuts 
- 8 3/8" lock washers 
- 8 3/8" Flat Washers 
- 4 9/16" Flat Plastic Washers 

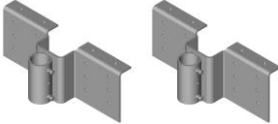

Side Mount Attachment Kit (Fixed and Floating)

Ensure that all of the parts are available before starting assembly.

- 2 Side Mount C Brackets 
- 4 Self Tapping Screws 
- 2 1/2" x 13" Stainless Steel Bolts 
- 2 1/2" Nylock Nuts 
- 2 Stainless Steel Washers 
- 2 Dock Brackets 
- 24 3/8" x 4" Carriage Bolts 
- 24 3/8" Nuts 
- 24 3/8" lock washers 
- 2 3/8" x 1" Stainless Steel Clamp Bolts 
- 2 3/8" Stainless Steel Back Nuts 
- 24 3/8" Flat Washers 



Basic Assembly Applicable to all Front Mount Applications

It is recommended that the basic fixing kit be applied to the Permaport away from the water to avoid the possibility of loss of components

It is essential that all threads are coated with an anti seize compound prior to assembly, failure to do so will complicate any future disassembly that may be required and will invalidate the warranty.

There are two large holes on each side of the front edge. Place a wear plate in both the top and the bottom hole. Install a C bracket on each side of the permaport. Insert a 13" long x 1/2" stainless steel bolt through the assembly and attach a 1/2" stainless steel Lock nut and washer on the bottom. Temporarily installing the 6" x 1/2" Bolt in the bracket assists with handling.

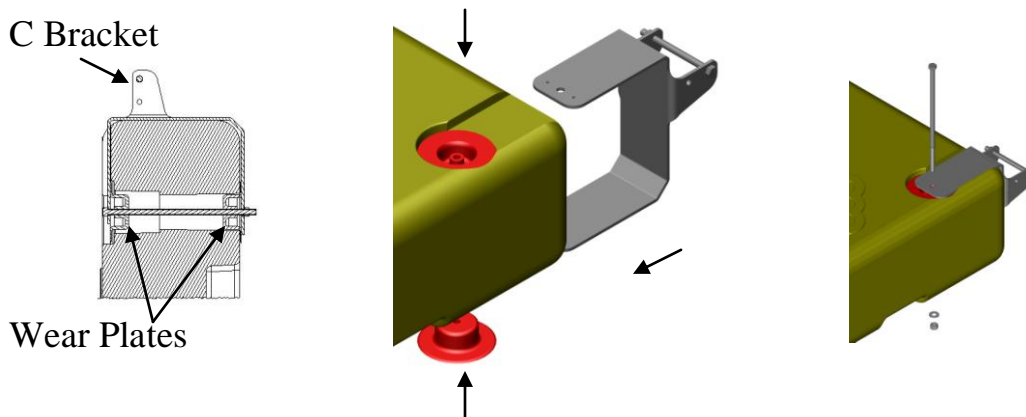

Tighten the nuts using a 3/4" wrench or Long Reach Socket, do not over tighten the nuts, they need to be snug without causing undue compression of the Permaport.

Attach the cleat to the front of the Permaport if desired in the position shown.



At this point, the permaport can be put into the water for attaching to the Dock.

Refer to specific Dock attachment instructions to complete installation.



Basic Assembly Applicable to all Side Mount Applications

It is recommended that the basic fixing kit be applied to the Permaport away from the water to avoid the possibility of loss of components

It is essential that all threads are coated with an anti seize compound prior to assembly, failure to do so will complicate any future disassembly that may be required and will invalidate the warranty.

There are two large holes on each side. Place a wear plate in both the top and the bottom hole. Install a “C” bracket at both the front and the rear of the Permaport on the side that is to be adjacent to the dock. Insert a 13” long x ½” stainless steel bolt through the assembly and attach a ½” stainless steel Lock nut and washer on the bottom.

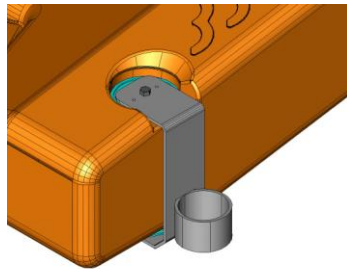
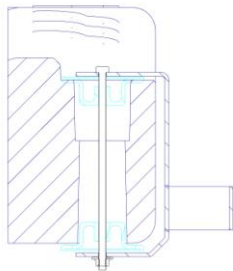

Tighten the nuts using a ¾” wrench or Long Reach Socket, do not over tighten the nuts, they need to be snug without causing undue compression of the Permaport.

Attach the cleat to the front of the Permaport if desired in the position shown.



At this point, the Permaport can be put into the water for attaching to the Dock.

Refer to specific Dock attachment instructions to complete installation.



Attaching a Front Mount to a Floating Dock

*It may be necessary to remove part of the Dock Planking in order to adequately fix the brackets on this assembly, Lag screws should not be used, it is critical that bolts and washers are used to mount this assembly. The permaport should not be attached to stringers that are less than 2" x 6" or in a decayed or damaged condition. **Take care not to drill through the floats under the dock***

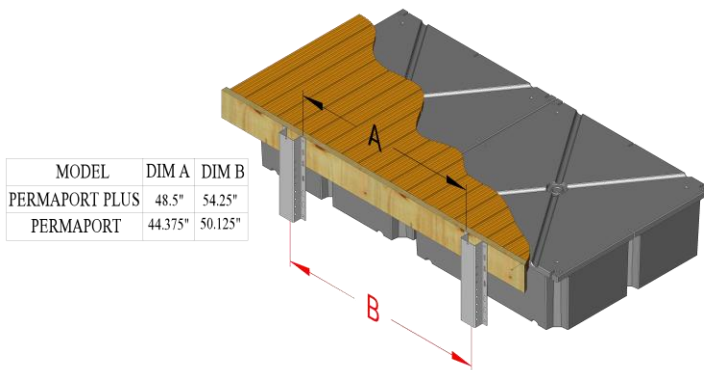

Determine the position that the Permaport is to be attached and mark a line on the stringer representing the center of the Permaport. Mark half of dim. "A" from the center line, this is the position of the inside line of bolts. Using a ⁹/₁₆" drill, drill and fix the attachment plate using carriage bolts and washers to

the dock through the Dock stringer. (Fix using one bolt only and then drill and fix the other three bolts using the plate as a guide). Repeat for the other plate, there should be dim "A" between the two inside lines of bolts which will give a center to center dimension of the two plates of the corresponding "B" dimension.

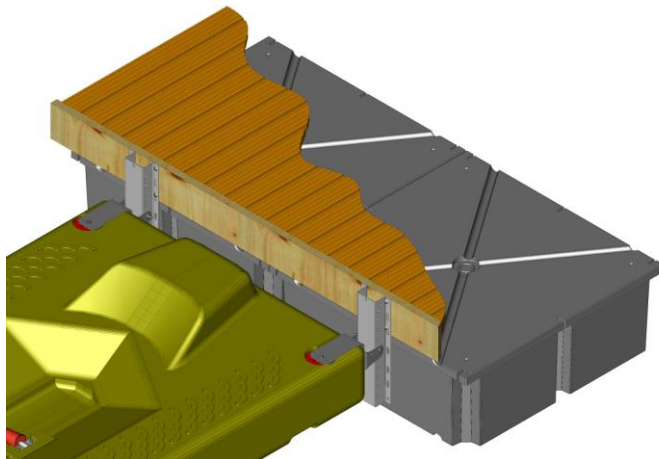

Bring the Permaport up to the dock and insert two 1/2" x 6" long Stainless steel bolts through the assembly.

IMPORTANT

Press down on the front of the Permaport to align the holes and insert the bolts in the next lowest hole position, do not lift the permaport to make the holes line up, if the holes naturally line up with the bracket, push down to capture the next set of holes below.



Attaching a front Mount to a Fixed Dock

This System Must Not Be Used If There Is The Possibility Of The Water Level Rising To Within 12" Of The Bottom Of The Pipe Brackets, contact your supplier for alternative instructions

It may be necessary to remove part of the Dock Planking in order to adequately fix the brackets on this assembly, Lag bolts should not be used, it is critical that Carriage bolts and the back plate are used to fix this assembly. The permaport should not be fixed to stringers that are less than 2" x 6" or in a decayed or damaged condition. It is essential that the poles on the fixed dock are both Parallel and Upright, if the poles are not parallel then the Permaport will bind as the water rises and falls, this could cause damage or loss to the Permaport, the watercraft or injury to persons.

Items required in addition to the Attachment Kit (not supplied).

- 2 Pieces Schedule 40, 1.5" or 2" (depending on system supplied) diameter galvanized pipes, long enough to reach from the top surface of the dock to 24" below the lake bed.

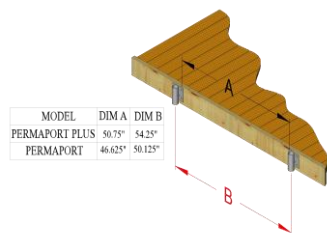

there should be Dim "A" between the two inside lines of bolts which will give a center to center dimension of the two tubes of Dim. "B"

Determine the position that the Permaport is to be attached and mark a line on the stringer representing the center of the Permaport. Mark half of Dim. "A" from the center line, this is the position of the inside line of bolts. Using a $\frac{9}{16}$ " drill, drill and fix the attachment plate to the dock through the dock stringer using carriage bolts, backing plate and washers (fix using one bolt only and then drill and fix the other three bolts using the plate as a guide). Repeat for the other plate,

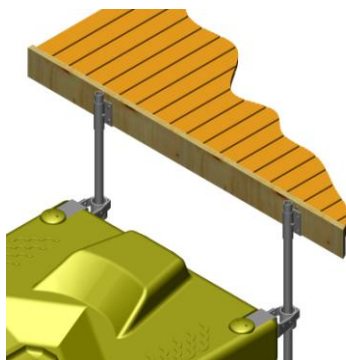

Attach the front brackets to the Permaport using the instructions on page 8. Add the tube sliders using the two 6" Stainless Steel Bolts. Slide the two 2" pipes down through the pipe clamps and through the permaport brackets the pipes should be driven into the bed of the lake for maximum strength.

Tighten the bolts on the pipe clamp. For added security, after installation, drill through both the pipe and the clamp with a $\frac{7}{16}$ " drill and bolt through with a $\frac{3}{8}$ " x 3" long bolt,



Attaching a Side Mount to a Dock

*It may be necessary to remove part of the Dock Planking in order to adequately fix the brackets on this assembly, Lag screws should not be used, it is critical that bolts and washers are used to mount this assembly. The permaport should not be attached to stringers that are less than 2" x 6" or in a decayed or damaged condition. **Take care not to drill through the floats under the dock***

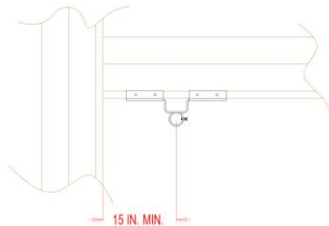

Bolt Side mount Dock bracket to Dock using 3/8" screws, nuts and washers provided if necessary use alternative lengths (not supplied) if the design of the dock dictates. Take note of the minimum distance of 15" from the front of the dock as shown.

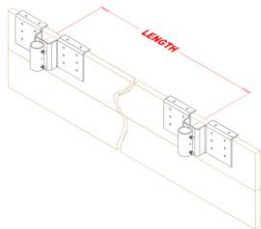

Measure the distance between the centers of the front and rear holes in the Permaport (this may vary between models of Permaport) and bolt the second Dock bracket in place the same distance between centers.

Move the Permaport into position and insert the 2" Galvanized pipe through the dock bracket and the Permaport bracket.

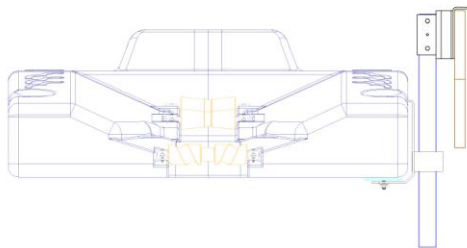

Tighten the bolts on the pipe clamp and lock with the Back nuts. For added security, after installation, drill through both the pipe and the clamp with a 7/16" drill and bolt through with a 3/8" x 3" long bolt.

It is critical that pipe extends at least 18" below the bottom of Permaport to allow for wave action.

This Kit can be used for side mounting on a fixed Dock, with fixed docks it is critical that the pipe extends into the lake bed and that they are installed Parallel to each other. (see instructions for front mounted Fixed docks for further details)



Fixed Dock Kit (Front Mount)

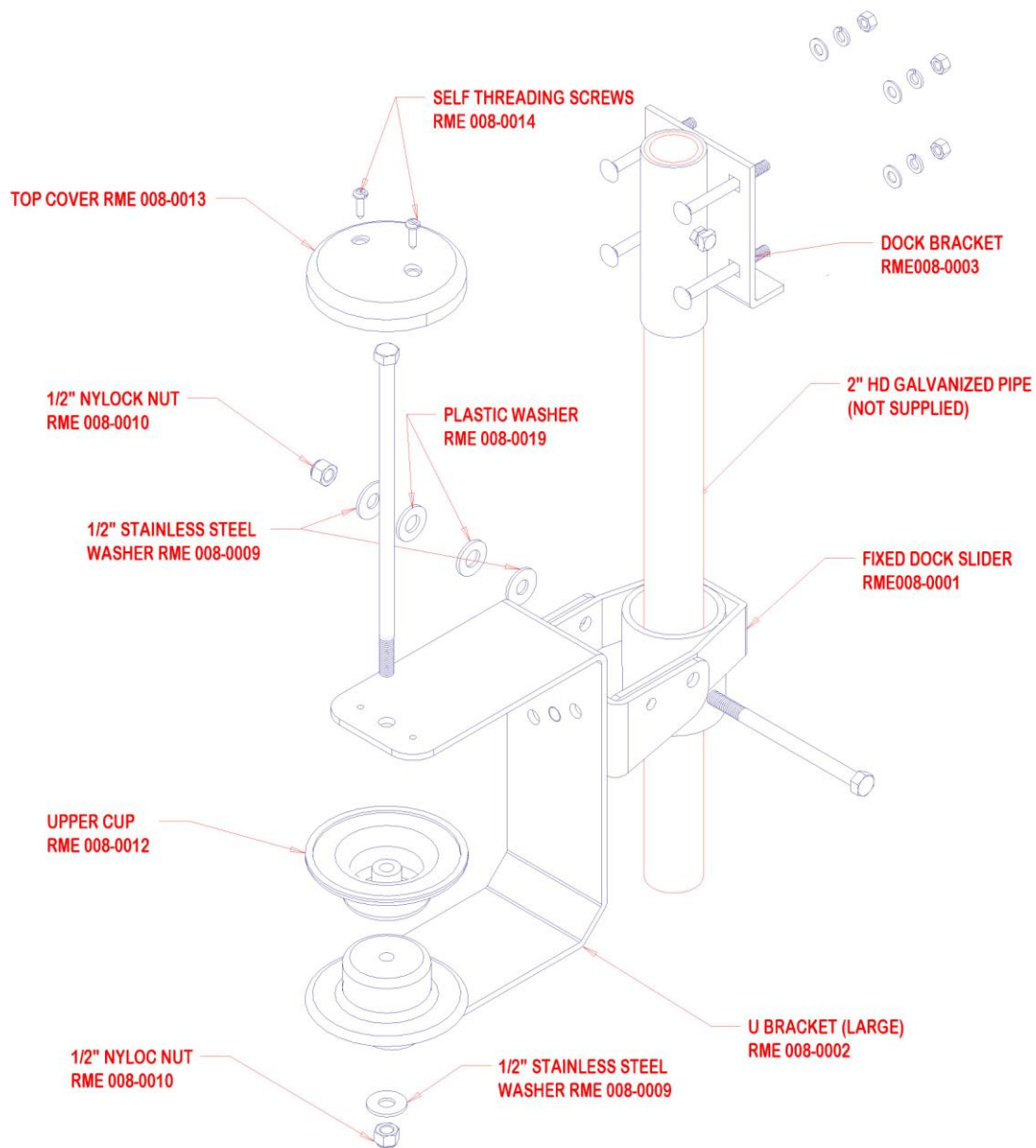



Floating Dock Kit (front Mount)

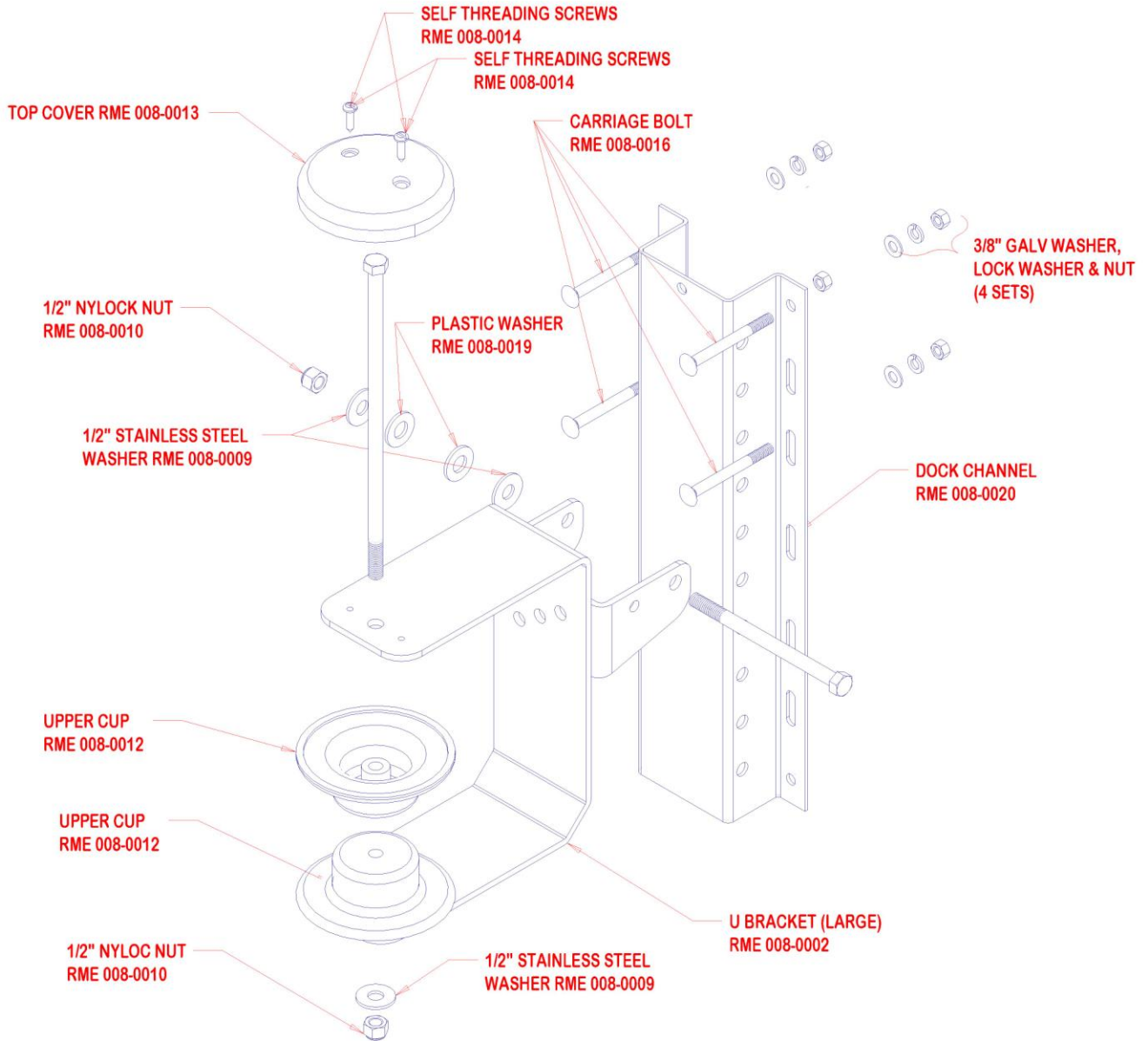



Fixed and Floating Side Mount Dock Kit

